

**DIN0002**

# Malia Teak Round Table 120



**(FR)** Notice de Montage -  
Utilisation - Entretien

**(IT)** Istruzioni per il Montaggio,  
l'Uso e la Manutenzione

**(DE)** Montage - Verwendung -  
Wartungshandbuch

**(ES)** Instrucciones de Montaje,  
Utilización y Mantenimiento

**(EN)** Assembly - Use -  
Maintenance Manual

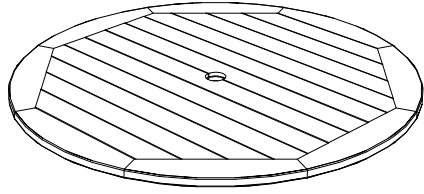
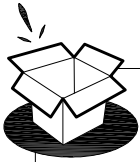

1

Hex Nut



A x8

Flat Ring Washer



C x8

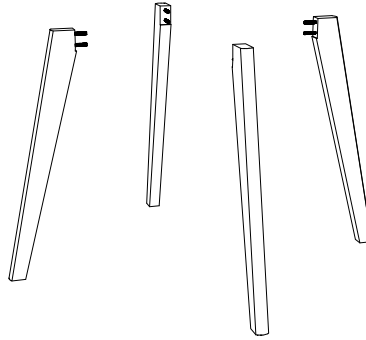

2

Wrench Key



B x1

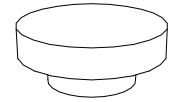

3

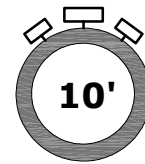

10'

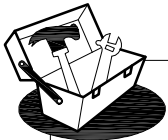
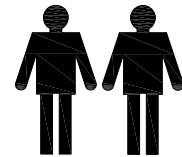

**NOT INCLUDED  
NON FOURNIS**



**A** x8

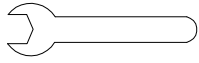

**B** x1

**C** x8

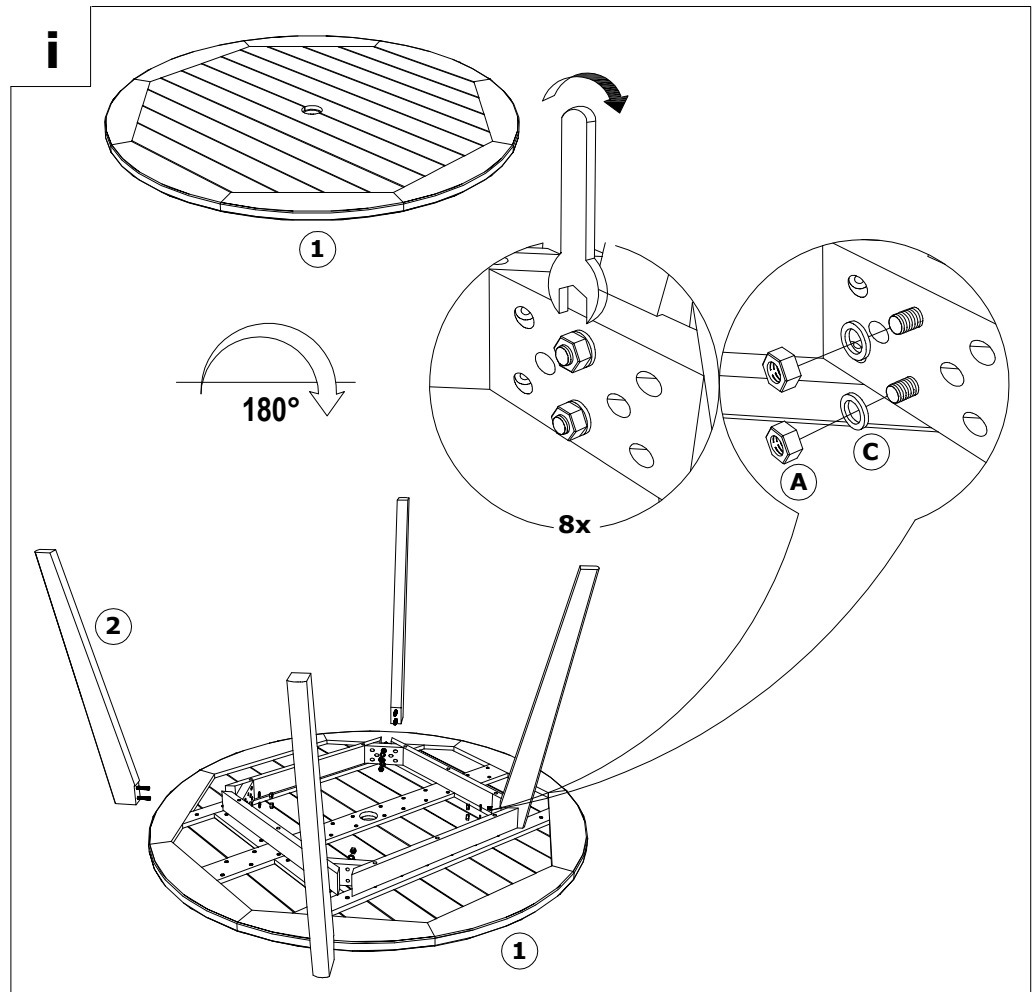

**3** x1

