

GC: \$\$ %
62)

@ [c`Gc]`%\$@j Yf`@cb[WUf`5fa `@%\$
FRPELQHG ZLWK /XJR \$UP 6R

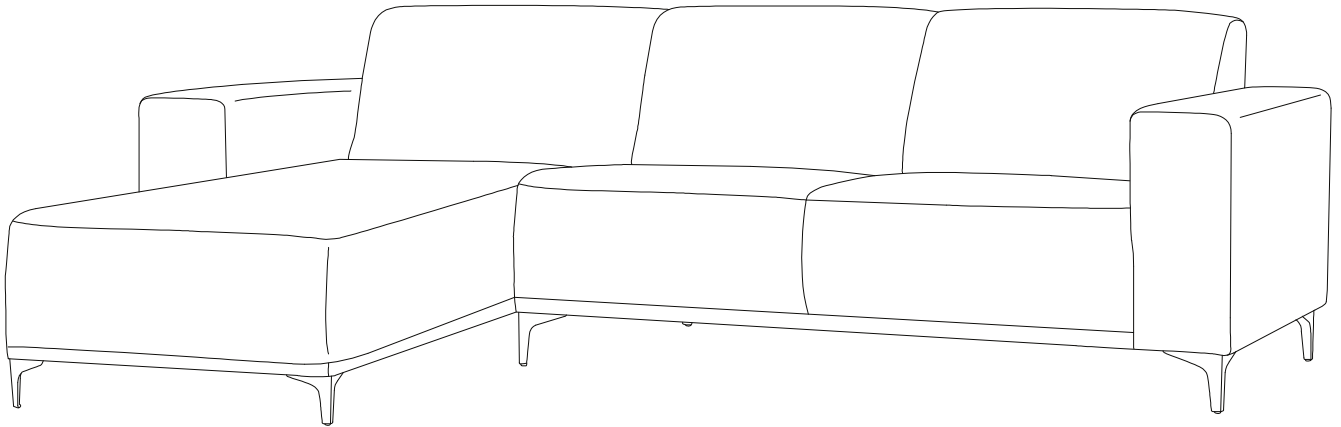

(15) 1RWLFH GH 0RQWDJH (17) ,VWUX]LRQL SHU LO 0RQWJLRQWDJH 9HUZHQG XQJ
8WLOLVDWLRQ (QWUHWLHQ 8VR H OD 0DQXWHQ]LRQH :DUWXQJVVDQGGEFK

(16) ,QVWUXFFLRQHV GH 0RQWJLRQWDJH 8VH
8WLOL]DFLyQ \ 0DQWHQLPLHQWRQWHQDQFH 0DQXD

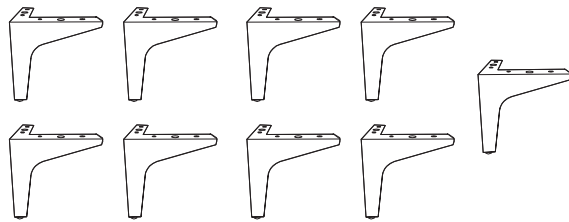
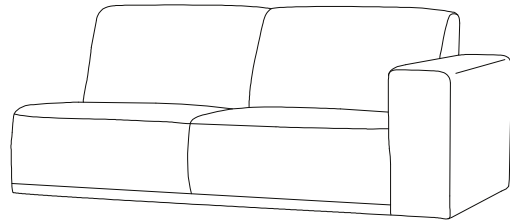
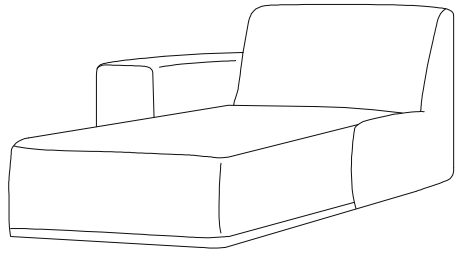
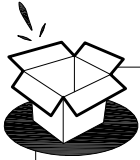

Bolts - M6X25

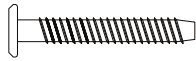

A 36pcs

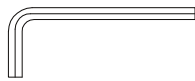

B 1pc

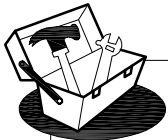
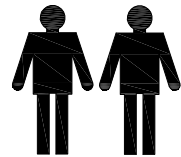
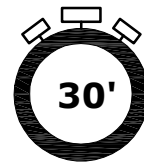

**NOT INCLUDED
NON FOURNIS**



A x16



B x1

i

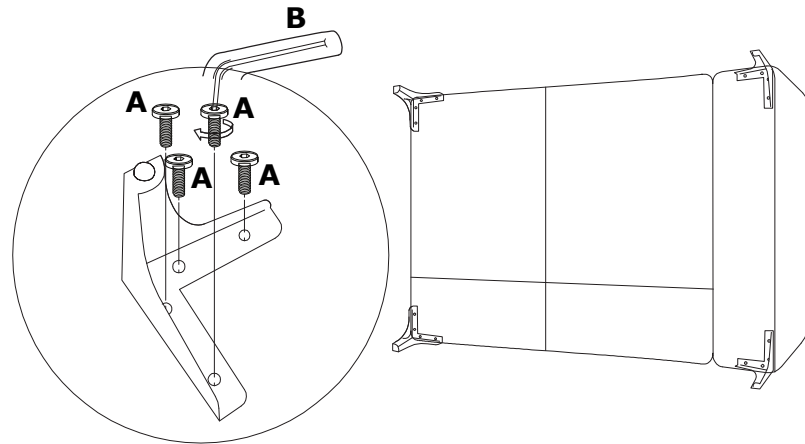
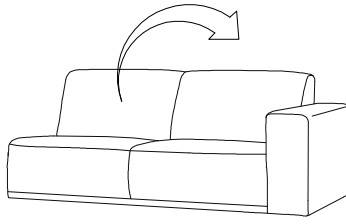

A x20



B x1

ii

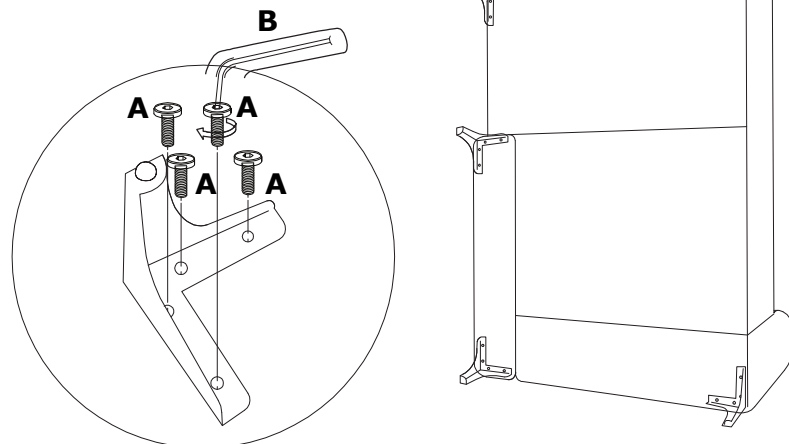
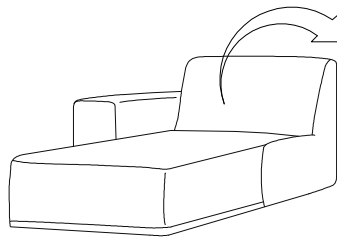

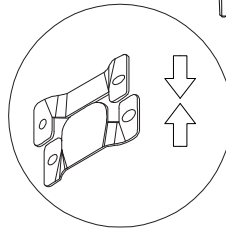
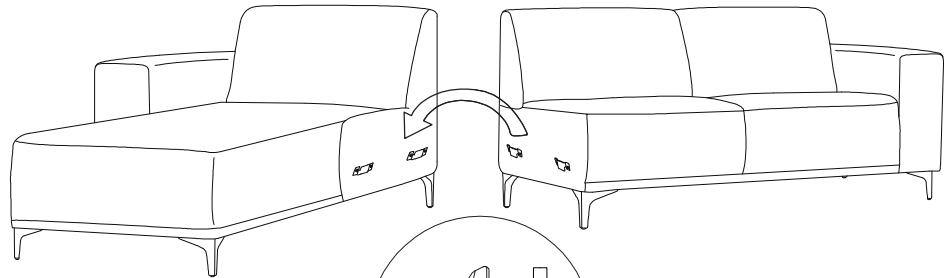

FR

Informations importantes

Lire attentivement

Suivre soigneusement chacune des étapes de ces instructions

Conserver ces instructions pour une utilisation ultérieure**RECOMMANDATION PRÉVENTIVE:**

- Ne pas faire glisser les meubles.
- Des protections supplémentaires pour les pieds sont recommandées en fonction du revêtement de sol.
- Différents types de revêtements de sol tels que le bois dur et le marbre nécessitent différentes protections pour répondre à leurs besoins d'entretiens.
- Vos coussins de canapé et de méridienne changent naturellement de forme suivant la fréquence de leur utilisation. Il est donc naturel qu'ils s'affaissent avec le temps.
- Entretien des tissus et enlever régulièrement les peluches augmentent la durabilité et l'aspect neuf du canapé.

IT

Avvertenze importanti

Da leggere con attenzione

Seguire attentamente ogni passaggio delle presenti istruzioni

Conservare queste istruzioni per riferimento futuro**RACCOMANDAZIONE PREVENTIVA:**

- Sollevare il mobile senza trascinarlo.
- Si consiglia l'utilizzo di ulteriori protezioni per i piedi a seconda del tipo di pavimento.
- Vari tipi di pavimenti, come il legno massello o il marmo, richiedono protezioni diverse per soddisfare alle proprie esigenze di protezione.
- I cuscini del divano e della poltrona cambiano naturalmente forma nel tempo. È dunque naturale che affiscino nel tempo.
- La cura regolare del tessuto, eliminando pallini e pelucchi eventuali, aumenta la durata di vita e l'estetica del divano.

DE

Wichtige Information

Bitte sorgfältig lesen!

Befolgen Sie sorgfältig jeden Schritt dieser Anleitung

Bewahren Sie diese Anleitung zur späteren Verwendung auf**VORBEUGENDE EMPFEHLUNG:**

- Verschieben Sie die Möbel nicht.
- Je nach Bodenbelag wird ein zusätzlicher Fußschutz empfohlen!
- Verschiedene Bodenbeläge wie Hartholz und Marmor erfordern unterschiedliche Schutzvorrichtungen, um ihren individuellen Anforderungen gerecht zu werden.
- Ihre Sofa- und Sesselkissen arbeiten hart und verändern im Laufe der Zeit auf natürliche Weise ihre Form. Sie verdienen ein wenig Verwöhnung von Zeit zu Zeit zur Zeit.
- Regelmäßige Pflege und Auflockern kann zu einem langlebigeren, jugendlicheren Sofa führen.

ES

Información importante

Leer atentamente

Siga cuidadosamente cada uno de los pasos de estas instrucciones

Guarde estas instrucciones para un uso posterior**RECOMENDACIONES PREVENTIVAS:**

- No deslice los muebles.
- Dependiendo del revestimiento del suelo, se recomienda utilizar protectores de pies adicionales!
- Diferentes tipos de pisos, como madera dura y mármol, requieren diferentes fusibles para satisfacer sus necesidades únicas.
- Los cojines de su sofá y chaise lounge trabajan duro y cambian de forma naturalmente con el tiempo.
- El mantenimiento regular y la esponjosidad pueden dar lugar a un sofá más duradero y juvenil.

EN

Important information

Read carefully

Follow each step of instruction carefully

Keep this information for further reference**PREVENTIVE RECOMMENDATION:**

- Do not slide the furniture.
- Additional foot protections are recommended depending on the floor covering!
- Various flooring types such as hardwood and marble require different protectors to suit their unique needs.
- Your couch and lounge chair cushions work hard and naturally change shape over time. They deserve a little pampering from time to time.
- Regular maintenance and fluffing can lead to a longer-lasting, more youthful sofa.